

Location of Controls

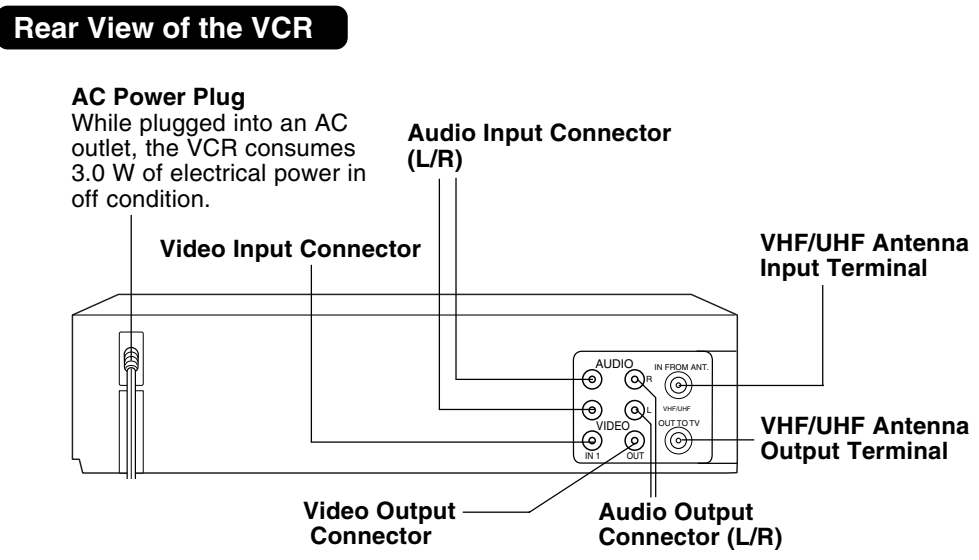
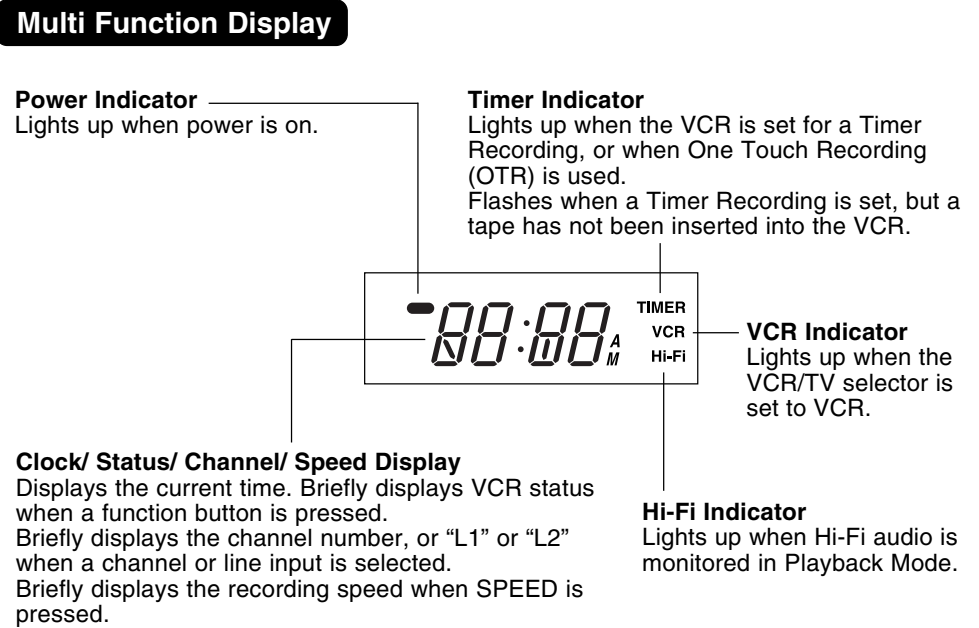

Spanish Quick Use Guide/ Guía para rápida consulta

CONEXIONES/CONFIGURACIÓN INICIAL (READY TO PLAY)

Realice la conexión de la antena o TV por cable antes de enchufar el cable de CA. La videograbadora iniciará automáticamente la fijación de los canales y del reloj al enchufar el cable de CA.

CONEXIONES

Para Ant/Cable → VCR → TV

- Conecte el cable de la antena al terminal IN FROM ANT del VCR.
- Conecte el terminal OUT TO TV del VCR a la entrada de la antena VHF/UHF del TV con el cable RF incluido.

PRECAUCIÓN
Al usar cables coaxiales RF del tipo "tuerca", apriételos solamente con los dedos. Un apriete excesivo puede dañar los terminales.

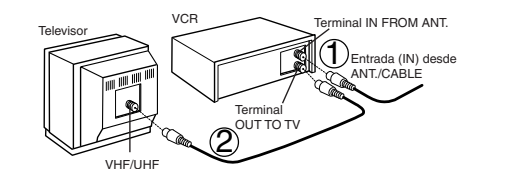

Para Sistema Digital de Satélite (DSS)/ Convertidor de cable → VCR → TV

- Conecte la salida de convertidor de cable al terminal IN FROM ANT.
- Conecte el terminal OUT TO TV del VCR a la entrada de la antena VHF/UHF del TV con el cable RF incluido.

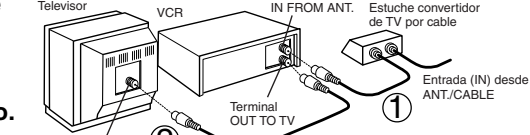

CONFIGURACIÓN INICIAL

- Encienda el TV y cambie al canal 3.
- Enchufe el cable de CA. La videograbadora se encenderá e iniciará las fijaciones de los canales y del reloj.
 - Si no aparece la pantalla de abajo, compruebe la conexión del VCR-TV y si el canal del TV está a 3, intente cambiando al canal 4.
 - Para cambiar el canal de salida del VCR, consulte las instrucciones de "Canal de salida del VCR" en la página 12 de las operaciones avanzadas.

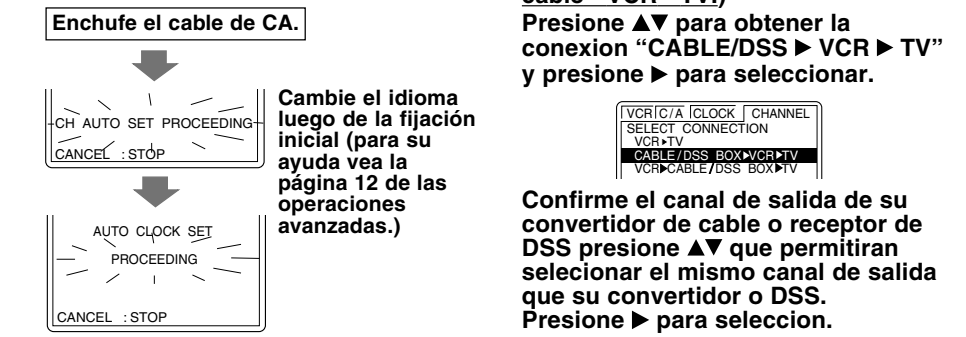

Si está usando un convertidor de TV por cable y en su área hay un canal de Public Broadcast Station (PBS), ajuste su convertidor al canal PBS de su área. Si está usando un receptor DSS, este debe estar apagado.

- Las fijaciones se realizan automáticamente. Cuando termina las fijaciones, aparecerá la siguiente pantalla.

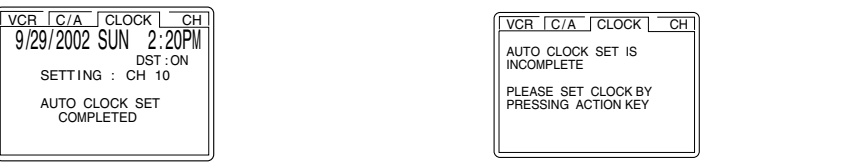

Ajuste Manual del Reloj

Si la colocacion de tiempo fue incompleta.

- Presione la tecla ACTION en el control remoto para visualizar la pantalla del menú RELOJ.

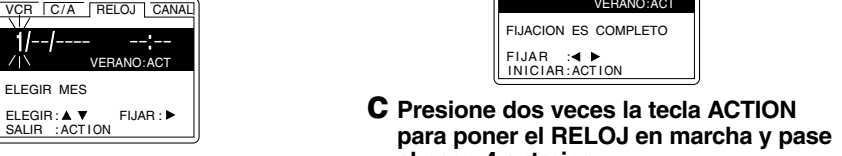

C Presione dos veces la tecla ACTION para poner el RELOJ en marcha y pase al paso 4 anterior.

Spanish Quick Use Guide/ Guía para rápida consulta

OPERACIONES BÁSICAS PARA LA REPRODUCCIÓN

- Inserte una cassette.
 - la alimentación del VCR se activa. En la Pantalla de Visualización Multi Función se ilumina "VCR".
- Presione PLAY para reproducir el cassette.
 - Si el cassette no tiene lengüeta de prevención de grabación (p. 3), se inicia la reproducción automáticamente.

Detalles especiales durante la grabación

- Presione FF o REW para búsqueda de escenas hacia delante/ hacia atrás. Presione PLAY para liberar. Luego de que la búsqueda se ha iniciado, cada vez que presione FF o REW se cambia la velocidad como sigue: [SLP] aprox. 21X ↔ aprox. 9X [LP] aprox. 9X ↔ aprox. 7X [SP] aprox. 7X ↔ aprox. 3X Si la imagen se interrumpe con la velocidad de 21x, 9x o 7x, cambie la velocidad a 9x, 7x o 3x.
- Presione PAUSE/SLOW para imagen fija (Congelada). Presione PLAY para liberar.
- Presione PAUSE/SLOW en el modo de Imagen fija para imágenes cuadro a cuadro. Presione PLAY para liberar.
- Mantenga pulsado PAUSE/SLOW en el modo de imagen fija para imágenes en cámara lenta. Presione PLAY para liberar.
- Presione STOP para detener el cassette.
- Presione REW o FF en el modo de parada para rebobinado/avance rápido del cassette.
- Presione EJECT en el control remoto, o STOP/EJECT en el VCR para expulsar el cassette.

OPERACIONES BÁSICAS PARA LA GRABACIÓN

- Inserte el cassette con lengüeta de protección de grabación (p. 3).
 - La alimentación del VCR se activa. En la pantalla Multi Función se ilumina "VCR".
- Presione CH ▲▼, o las teclas de números para seleccionar el canal.
 - SP = Reproducción estándar,
 - LP = Larga duración,
 - SLP = Superlarga duración.
- Presione SPEED para seleccionar la velocidad de grabación (p. 3).
 - Para eliminar escenas indeseadas, presione PAUSE/SLOW para pausar, y al presionar nuevamente se reanuda la grabación.
- Presione REC para comenzar a grabar.
 - Para cancelar programas... Presione ADD/HLT
- Presione STOP para detener la grabación.
 - Grabación de un toque. Presione REC repetidamente para ajustar la duración de la grabación como sigue: como sigue: 30 min. → 1 hr → 1:30hr → 2:00 → 3:00 → 4:00 → Salida. La VCR se apagará automáticamente en un intervalo seleccionado de tiempo.
 - Ver un canal y grabar otro. Presione VCR/TV. (La indicación VCR se apagará en la "visualización de Multi-Función") → Selección canales de TV (Mientras permanece grabando)
 - Selección canales con VCR. Presione VCR/TV (la indicación "VCR" se encenderá en la visualización multi-función) → Selección canales en su VCR.

Spanish Quick Use Guide/ Guía para rápida consulta

ANTES DE SOLICITAR AL SERVICIO TÉCNICO

Verifique los siguientes puntos una y otra vez si esta teniendo problemas con su VCR. (BO : Haga referencia en las instrucciones de funcionamiento [Operaciones Básicas]) (AO : Haga referencia el la instrucciones de funcionamiento [Operaciones Avanzadas])

ALIMENTACIÓN DE AC	CORRECCIÓN
La unidad no enciende....	<ul style="list-style-type: none"> Revise que el cordón de alimentación de AC este correctamente conectado a la toma de pared. Presione el botón "POWER" para el encendido de la unidad. Verifique que la fuente de alimentación está activada.
GRABACIÓN Y REPRODUCCIÓN (REC / PLAY)	CORRECCIÓN
No se pueden grabar programas de TV	<ul style="list-style-type: none"> Revise las conexiones entre VCR, antena externa o cable y TV. Verifique la selección de conexiones (BO p. 4, AO p. 3) Verifique que su sistema de antena (Cable o TV) estén correctamente seleccionados. Vea "Channels" (AO p. 12). Asegúrese que la pestaña en el cassette de grabación esté intacta (BO p. 3).
No se puede efectuar grabación con temporizador...	<ul style="list-style-type: none"> Compruebe que el reloj ha sido ajustado a la hora y fecha actual. Asegúrese de que la caja de Cable/DSS (si se utiliza) se deja encendido y está sincronizado al canal a grabar. Ajuste las horas de comienzo y detección de grabación correctamente. (BO p. 6) Asegúrese de que ha apagado el VCR antes de la grabación. (BO p. 6) La grabación con temporizador quizás no pueda realizarse o continuarse si se produjera una interrupción de corriente antes o durante una grabación con temporizador, incluso después de restablecido el fluido eléctrico.
No hay imagen de reproducción, o la imagen de reproducción tiene ruidos o contiene rayas...	<ul style="list-style-type: none"> Selección el canal 3 o 4 en el televisor, de modo que corresponda con el canal de salida del videograbador (3 o 4) (BO p. 4), o selección LINE. Ajuste el selector VCR/TV a "VCR". Ajuste el control TRACKING en una de las dos direcciones. (BO p. 3) Pruebe a realizar la limpieza de cabezales. (BO p. 3)
En la reproducción de efectos especiales, la imagen puede contener algunos saltos verticales cuando se utiliza un televisor con Control de Bloqueo Vertical Automático...	<ul style="list-style-type: none"> Ponga el Control de Bloqueo Vertical del televisor en "MANUAL" y luego realice el ajuste.
No se puede controlar el VCR...	<ul style="list-style-type: none"> Asegúrese de que el aparato está encendido. Revise las pilas del control remoto. Asegúrese de que el BLOQUEO DEL VCR esté ajustado a INACTIVO (AO p. 10) Asegúrese de que no está funcionando una grabación con temporizador.
CONTROL REMOTO	CORRECCIÓN
NO funciona el control remoto...	<ul style="list-style-type: none"> Asegúrese de que el aparato está encendido. Asegúrese de que el control remoto está en el modo de VCR. Ajuste el control remoto directamente al sensor remoto del VCR. (BO p. 7) Evite que ningún objeto interrumpa la señal del control remoto. Revise las pilas del control remoto (BO p. 3) Asegúrese de que el BLOQUEO DEL VCR esté ajustado a INACTIVO (AO p. 10) Si el sensor remoto recibe directamente la luz del fluorescente o luz solar puede causar interferencia con la señal del control remoto.
Los botones "ACTION" y/o "PROG" no responden...	<ul style="list-style-type: none"> Verifique las conexiones entre VCR, cable o antena y TV. Presione el botón VCR para el modo de "VCR". (AO p. 2) Revise las baterías del control remoto. (BO p. 3)
Varios	CORRECCIÓN
No se pueden ver los programas en el televisor...	<ul style="list-style-type: none"> Asegúrese que la TV este encendida. Asegúrese que la TV esté conectado a la salida de la VCR (VCR Out). Verifique conexiones entre VCR, cable o antena y TV. Ajuste el selector VCR/TV a "TV". (BO p. 5) Asegúrese que la apropiada señal fue seleccionada.
No se puede introducir la cassette de video...	<ul style="list-style-type: none"> Inserte el cassette con el lado de la ventana hacia arriba y la pestaña de grabación frente a usted. Verifique que no tenga ningún cassette dentro del aparato.
No se puede extraer la cassette de video...	<ul style="list-style-type: none"> Inserte o conecte completamente el cable de alimentación de AC a la toma de pared.
La cassette de video es expulsada al dar comienzo a una grabación o al desactivar la alimentación para la grabación con teporizador...	<ul style="list-style-type: none"> Asegúrese que la pestaña de grabación del cassette este intacta. (BO p. 3)
En el modo de Detención, el motor (CILINDRO) sigue girando...	<ul style="list-style-type: none"> Para activar rápidamente el mecanismo de reproducción, el cilindro sigue rotando durante 3 minutos. Esto disminuye el tiempo de respuesta desde la parada hasta la reducción o hasta el a modo de búsqueda en rebobinado.

Si no puede resolver su problema, por favor comunicarse al Centro de llamadas del Cliente para asistencia del producto al 1-800-211-PANA(7262). Para localizar un centro de servicios autorizado, llame sin costo al 1-800-211-PANA(7262) o envíe un correo a : consumerproducts@panasonic.com

Limited Warranty

PANASONIC CONSUMER ELECTRONICS COMPANY, DIVISION OF MATSUSHITA ELECTRIC CORPORATION OF AMERICA
One Panasonic Way Secaucus, New Jersey 07094

PANASONIC SALES COMPANY, DIVISION OF MATSUSHITA ELECTRIC OF PUERTO RICO, INC., Ave. 65 de Infantería, Km. 9.5 San Gabriel Industrial Park, Carolina, Puerto Rico 00985

Panasonic VHS VCR Products Limited Warranty

Limited Warranty Coverage
If your product does not work properly because of a defect in materials or workmanship, Panasonic Consumer Electronics Company or Panasonic Sales Company (collectively referred to as "the warrantor") will, for the length of the period indicated on the chart below, which starts with the date of original purchase ("warranty period"), at its option either (a) repair your product with new or refurbished parts, or (b) replace it with a new or a refurbished product. The decision to repair or replace will be made by the warrantor.

Product or Part Name	Parts	Labor
All components of VCR except item listed below	One (1) Year	Ninety (90) Days
Video Tape (in exchange for defective video tape)	Five (5) Days	Not Applicable

During the "Labor" warranty period there will be no charge for labor. During the "Parts" warranty period, there will be no charge for parts. You must mail-in your product during the warranty period. If non-rechargeable batteries are included, they are not warranted. This warranty only applies to products purchased and serviced in the United States or Puerto Rico. This warranty is extended only to the original purchaser of a new product which was not sold "as is".

Mail-In Service
For assistance in the continental U.S.A. in obtaining repairs please ship the product to:
Panasonic Services Company
Customer Service Center Suite B
4900 George McVay Drive
McAllen, TX 78503

For assistance in Puerto Rico call Panasonic Sales Company (787) 750-4300 or fax (787)768-2910
When shipping the unit carefully pack and send it prepaid, adequately insured and preferably in the original carton. Include a letter detailing the complaint and provide a day time phone number where you can be reached.

IF REPAIR IS NEEDED DURING THE WARRANTY PERIOD THE PURCHASER WILL BE REQUIRED TO FURNISH A SALES RECEIPT/PROOF OF PURCHASE INDICATING DATE OF PURCHASE, AMOUNT PAID AND PLACE OF PURCHASE. CUSTOMER WILL BE CHARGED FOR THE REPAIR OF ANY UNIT RECEIVED WITHOUT SUCH PROOF OF PURCHASE.

Limited Warranty Limits And Exclusions
This warranty ONLY COVERS failures due to defects in materials or workmanship, and DOES NOT COVER normal wear and tear or cosmetic damage. The warranty ALSO DOES NOT COVER damages which occurred in shipment, or failures which are caused by products not supplied by the warrantor, or failures which result from accidents, misuse, abuse, neglect, mishandling, misapplication, alteration, faulty installation, set-up adjustments, misadjustment of consumer controls, improper maintenance, power line surge, lightning damage, modification, introduction of sand, humidity or liquids, commercial use such as hotel, office, restaurant, or other business or rental use of the product, or service by anyone other than a Factory Servicenter or other Authorized Servicer, or damage that is attributable to acts of God.

THERE ARE NO EXPRESS WARRANTIES EXCEPT AS LISTED UNDER "LIMITED WARRANTY COVERAGE". THE WARRANTOR IS NOT LIABLE FOR INCIDENTAL OR CONSEQUENTIAL DAMAGES RESULTING FROM THE USE OF THIS PRODUCT, OR ARISING OUT OF ANY BREACH OF THIS WARRANTY. (As examples, this excludes damages for lost time, cost of having someone remove or re-install an installed unit if applicable, travel to and from the servicer, loss of or damage to media or images, data or other recorded content. The items listed are not exclusive, but are for illustration only.)
ALL EXPRESS AND IMPLIED WARRANTIES, INCLUDING THE WARRANTY OF MERCHANTABILITY, ARE LIMITED TO THE PERIOD OF THE LIMITED WARRANTY.
Some states do not allow the exclusion or limitation of incidental or consequential damages, or limitations on how long an implied warranty lasts, so the exclusions may not apply to you. This warranty gives you specific legal rights and you may also have other rights which vary from state to state. If a problem with this product develops during or after the warranty period, you may contact your dealer or Servicenter. If the problem is not handled to your satisfaction, then write to the warrantor's Consumer Affairs Department at the addresses listed for the warrantor.

PARTS AND SERVICE, WHICH ARE NOT COVERED BY THIS LIMITED WARRANTY, ARE YOUR RESPONSIBILITY.

Customer Services Directory

For Product Information, Operating Assistance, Literature Request, Dealer Locations, and all Customer Service inquiries please contact:
1-800-211-PANA (7262), Monday-Friday 9 am-9 pm; Saturday-Sunday 9 am-7 pm, EST. or send e-mail : consumerproducts@panasonic.com

Web Site: <http://www.panasonic.com>
You can purchase parts, accessories or locate your nearest servicenter by visiting our Web Site.

Accessory Purchases:
1-800-332-5368 (Customer Orders Only)
Panasonic Services Company 20421 84th Avenue South, Kent, WA 98032
(6 am to 5 pm Monday - Friday; 6 am to 10:30 am Saturday; PST)
(Visa, MasterCard, Discover Card, American Express, Check)

Service in Puerto Rico
Matsushita Electric of Puerto Rico, Inc. Panasonic Sales Company/ Factory Servicenter:
Ave. 65 de Infantería, Km. 9.5, San Gabriel Industrial Park, Carolina, Puerto Rico 00985
Phone (787)750-4300 Fax (787)768-2910

Panasonic



Video Cassette Recorder Operating Instructions (Basic Operations)

For advanced operations, see the separate "Advanced Operations" instruction book.

Model No. PV-V4612/PV-V4612S



Table of Contents

Important Safeguards and Precautions 2
Before Using 3
Connections and Initial Setup (Ready to Play) 4
Playback / Record on a Tape 5
Timer Recording 6
Location of Controls 7, 8
Spanish (Español) Quick Use Guide 9, 10, 11
Limited Warranty / Customer Services Directory 12

VCR Plus+
VCR Plus+ and PlusCode are registered trademarks of Gemstar Development Corporation. The VCR Plus+ system is manufactured under license from Gemstar Development Corporation.

Energy Star
As an ENERGY STAR® Partner, Matsushita Electric Corporation of America has determined that this product or product model meets the ENERGY STAR® guidelines for energy efficiency.

Please read these instructions carefully before attempting to connect, operate or adjust this product. Please save this manual. Spanish Quick Use Guide is included. (Guía para rápida consulta en español está incluida.)

Important Safeguards and Precautions

FOR YOUR SAFETY, READ AND RETAIN ALL SAFETY AND OPERATING INSTRUCTIONS. HEED ALL WARNINGS IN THE MANUAL AND ON THE UNIT.

INSTALLATION

1 POWER SOURCE CAUTION
Operate only from a power source indicated on the unit or in this manual. If necessary, have your Electric Utility Service Company or Video Products Dealer verify the power source in your home.

2 POLARIZED OR GROUNDING PLUG
As a safety feature, this Video product comes with either a polarized video cord plug (one blade is wider than the other), or a three-wire grounding type plug.

POLARIZED PLUG CAUTION:
This plug will only fit into an outlet one way. If you cannot fully insert the plug, try reversing it. If it still will not fit, have an electrician install the proper wall outlet. Do not defeat the safety feature by tampering with the plug.

GROUNDING PLUG CAUTION:
This plug will only fit into a three-hole grounding outlet. If necessary, have an electrician install the proper outlet. Do not defeat the safety feature by tampering with the plug.

3 POWER CORD
Make sure power cords are routed so that they are not likely to have anything rest on them, roll over them, or be in the way of walking traffic.

If an extension cord is used, make sure it also has either a polarized or grounded plug and that the cords can be securely connected. Frayed cords, damaged plugs, and damaged or cracked wire insulation are hazardous and should be replaced by a qualified service technician.

4 DO NOT BLOCK VENTILATION HOLES
Ventilation openings in the cabinet release heat generated during operation. If they are blocked, heat build-up inside the unit can cause failures that may result in a fire hazard or heat damage to cassettes. For protection, follow these rules:

- Never cover ventilation slots or the unit while in use, or operate the unit when placed on a bed, sofa, rug, or other soft surface.
- Avoid built-in installation, such as a book case or rack, unless proper ventilation is provided.

5 AVOID EXTREMELY HOT LOCATIONS OR SUDDEN TEMPERATURE CHANGES
Do not place the unit over or near any kind of heater or radiator, in direct sunlight, inside a closed vehicle, etc. Do not move the unit suddenly between areas of extreme temperature variation. If the unit is suddenly moved from a cold place to a warm place, moisture may condense in the unit and on the tape.

6 TO AVOID PERSONAL INJURY

- Do not place unsecured equipment on a sloping surface.
- Do not place this unit on any support that is not firm, level, and adequately strong. The unit could fall causing serious injury to a child or adult and damage to the unit.
- An appliance and cart combination should be moved with care. Quick stops, excessive force, and uneven surfaces may cause the appliance and cart combination to overturn.
- Carefully follow all operating instructions and use the manufacturer's recommended accessories when operating this unit or connecting it to any other equipment.

SAFETY PRECAUTIONS

Warning: To prevent fire or shock hazard, do not expose this equipment to rain or moisture.

CAUTION: To prevent electric shock, match wide blade of plug to wide slot, fully insert.

Avertissement: Afin de prévenir tout risque d'incendie ou de chocs électriques, ne pas exposer cet appareil à la pluie ou à une humidité excessive.

Attention: Pour éviter les chocs électriques, introduire la lame la plus large de la fiche dans la borne correspondante de la prise et pousser jusqu'au fond.

This symbol warns the user that uninsulated voltage within the unit may have sufficient magnitude to cause electric shock. Therefore, it is dangerous to make any kind of contact with any inside part of this unit.

This symbol alerts the user that important literature concerning the operation and maintenance of this unit has been included. Therefore, it should be read carefully in order to avoid any problems.

CAUTION
RISK OF ELECTRIC SHOCK
DO NOT OPEN

CAUTION: TO REDUCE THE RISK OF ELECTRIC SHOCK, DO NOT REMOVE COVER (OR BACK). NO USER-SERVICEABLE PARTS INSIDE. REFER SERVICING TO QUALIFIED SERVICE PERSONNEL.

FCC Warning: Any unauthorized changes or modifications to this equipment would void the user's authority to operate.

CAUTION
RISK OF ELECTRIC SHOCK
DO NOT OPEN

CAUTION: TO REDUCE THE RISK OF ELECTRIC SHOCK, DO NOT REMOVE COVER (OR BACK). NO USER-SERVICEABLE PARTS INSIDE. REFER SERVICING TO QUALIFIED SERVICE PERSONNEL.

FCC Warning: Any unauthorized changes or modifications to this equipment would void the user's authority to operate.

OUTDOOR ANTENNA INSTALLATION

SAFE ANTENNA AND CABLE CONNECTION

If an outside antenna or cable system is connected to the equipment, be sure the antenna or cable system is grounded so as to provide some protection against built up static charges and voltage surges.

Section 810 of the National Electrical Code, ANSI/NFPA 70 (in Canada, part 1 of the Canadian Electrical Code) provides information with respect to proper grounding of the mast and supporting structure, grounding of the lead-in wire to an antenna discharge unit, size of grounding conductors, location of antenna discharge unit, connection to grounding electrodes and requirements for the grounding electrode.

2 KEEP ANTENNA CLEAR OF HIGH VOLTAGE POWER LINES OR CIRCUITS

An outside antenna system should be located well away from power lines, electric light or power circuits and where it will never come into contact with these power sources if it should happen to fall. When installing an outside antenna, extreme care should be taken to avoid touching power lines, circuits or other power sources as this could be fatal. Because of the hazards involved, antenna installation should be left to a professional.

USING THE VIDEO UNIT

If the unit has been in storage or moved to a new location, refer first to the INSTALLATION section of these safeguards.

1 KEEP THIS VIDEO UNIT AWAY FROM WATER OR MOISTURE OF ANY KIND.

2 IF EQUIPMENT IS EXPOSED TO RAIN, MOISTURE, OR STRONG IMPACT, unplug the unit and have it inspected by a qualified service technician before use.

3 DURING AN ELECTRICAL STORM
During a lightning storm, whether indoors or outdoors, or before leaving the unit unused for extended periods of time, disconnect all equipment from the power source as well as the antenna and cable system.

4 WHEN THE UNIT IS PLUGGED IN

Never expose the unit to rain or water. DO NOT OPERATE if liquid has been spilled into the unit. Immediately unplug the unit, and have it inspected by a service technician. Fire and shock hazards can result from electrical shorts caused by liquid contact inside.

Never drop or push any object through openings in the unit. Some internal parts carry hazardous voltages and contact can cause electric shock or fire hazard.

Avoid placing the unit directly above or below your TV set as this may cause electrical interference. Keep all magnets away from electronic equipment.

5 USING ACCESSORIES

Use only accessories recommended by the manufacturer to avoid risk of fire, shock, or other hazards.

6 CLEANING THE UNIT

Unplug the unit. Then, use a clean, dry, chemically untreated cloth to gently remove dust or debris. DO NOT USE cleaning fluids, aerosols, or forced air that could over-pressure, or seep into the unit and cause electrical shock. Any substance such as wax, adhesive tape, etc. may mar the cabinet surface. Exposure to greasy, humid, or dusty areas may adversely affect internal parts.

SERVICE

1. DO NOT SERVICE THIS PRODUCT YOURSELF

If, after carefully following the detailed operating instructions, this Video product does not operate properly, do not attempt to open or remove covers, or make any adjustments not described in the manual. Unplug the unit and contact a qualified service technician.

2 IF REPLACEMENT PARTS ARE REQUIRED

Make sure the service technician uses only parts specified by the manufacturer, or those having the same safety characteristics as the original parts. The use of unauthorized substitutes may result in fire, electric shock, or other hazards.

HAVE THE SERVICE TECHNICIAN PERFORM A SAFETY CHECK

After any service or repairs to the unit, request the service technician to conduct a thorough safety check as described in the manufacturer's service literature to ensure that the video unit is in safe operating condition.

Before Using

Congratulations

on your new purchase! With proper use, this dependable product will provide years of enjoyment. Please fill in the information below. (Serial Number is on tag on back of VCR.)

• Date of Purchase _____

• Dealer Purchased From _____

• Dealer Address _____

• Dealer Phone No. _____

• Model No. _____

• Serial No. _____

Accessories

Remote Control
LSSQ0313 (PV-V4612)
LSSQ0343 (PV-V4612S)

Batteries 2 "AA"

RF Coaxial Cable
VJAS0196

Loading the Batteries

To order accessories, call toll free 1-800-332-5368.

Using the Video Unit

If the unit has been in storage or moved to a new location, refer first to the INSTALLATION section of these safeguards.

1 KEEP THIS VIDEO UNIT AWAY FROM WATER OR MOISTURE OF ANY KIND.

2 IF EQUIPMENT IS EXPOSED TO RAIN, MOISTURE, OR STRONG IMPACT, unplug the unit and have it inspected by a qualified service technician before use.

3 DURING AN ELECTRICAL STORM
During a lightning storm, whether indoors or outdoors, or before leaving the unit unused for extended periods of time, disconnect all equipment from the power source as well as the antenna and cable system.

4 WHEN THE UNIT IS PLUGGED IN

Never expose the unit to rain or water. DO NOT OPERATE if liquid has been spilled into the unit. Immediately unplug the unit, and have it inspected by a service technician. Fire and shock hazards can result from electrical shorts caused by liquid contact inside.

Never drop or push any object through openings in the unit. Some internal parts carry hazardous voltages and contact can cause electric shock or fire hazard.

Avoid placing the unit directly above or below your TV set as this may cause electrical interference. Keep all magnets away from electronic equipment.

5 USING ACCESSORIES

Use only accessories recommended by the manufacturer to avoid risk of fire, shock, or other hazards.

6 CLEANING THE UNIT

Unplug the unit. Then, use a clean, dry, chemically untreated cloth to gently remove dust or debris. DO NOT USE cleaning fluids, aerosols, or forced air that could over-pressure, or seep into the unit and cause electrical shock. Any substance such as wax, adhesive tape, etc. may mar the cabinet surface. Exposure to greasy, humid, or dusty areas may adversely affect internal parts.

SERVICE

1. DO NOT SERVICE THIS PRODUCT YOURSELF

If, after carefully following the detailed operating instructions, this Video product does not operate properly, do not attempt to open or remove covers, or make any adjustments not described in the manual. Unplug the unit and contact a qualified service technician.

2 IF REPLACEMENT PARTS ARE REQUIRED

Make sure the service technician uses only parts specified by the manufacturer, or those having the same safety characteristics as the original parts. The use of unauthorized substitutes may result in fire, electric shock, or other hazards.

HAVE THE SERVICE TECHNICIAN PERFORM A SAFETY CHECK

After any service or repairs to the unit, request the service technician to conduct a thorough safety check as described in the manufacturer's service literature to ensure that the video unit is in safe operating condition.

Record/Playback Time

Only use tapes with the **VHS** mark in this unit.

Tape Speed Setting

Type of Video Cassette

	T60	T120	T160
SP (Standard Play)	1 Hour	2 Hours	40 Minutes
LP (Long Play)	2 Hours	4 Hours	5 Hours 20 Minutes
SLP (Super Long Play)	3 Hours	6 Hours	8 Hours

Record/Playback Time

Only use tapes with the **VHS** mark in this unit.

Tape Speed Setting

Type of Video Cassette

	T60	T120	T160
SP (Standard Play)	1 Hour	2 Hours	40 Minutes
LP (Long Play)	2 Hours	4 Hours	5 Hours 20 Minutes
SLP (Super Long Play)	3 Hours	6 Hours	8 Hours

Connections / Initial Setup (Ready to Play)

Connecting

For ANT./Cable → VCR → TV

① Connect cable from Antenna/Cable to VCR's IN FROM ANT. jack.

② Connect VCR's OUT TO TV jack to TV's ANT. IN jack with included RF Cable accessory.

For DSS/Cable Box → VCR → TV

① Connect your cable box's OUT jack to the VCR's IN FROM ANT. jack with an RF cable.

② Connect VCR's OUT TO TV jack to TV's ANT. IN jack with included RF Cable accessory.

Cleaning the VCR

Use soft, dry cloth or dusting attachment of a vacuum to remove dust from all cabinet vent holes. You may moisten cloth with nonabrasive, antistatic cleaner/ polisher.

Caution:
Alcohol and various solvents could damage finish.

Specifications

Power Source: 120 V AC, 60 Hz

Power Consumption: Power On
Approx. 23 W
Power Off
Approx. 3.0 W

Video Signal: EIA Standard NTSC color

Video Recording System: 4 rotary heads helical scanning system

Audio Track: 1 track (Normal)
2 channel
Hi-Fi Audio Sound

Tuner: Midband A - 1 (14 - 22)

Broadcast Channels: Superband J - W (23 - 36)

CABLE Channels: Hyperband AA - EEE (37 - 64)
Lowband A-5 - A-1 (95 - 99)
Special CABLE channel 5A (01)
UltraBand 65 - 94, 100 - 125

Operating Temperature: 5 °C ~ 40 °C (41 °F ~ 104 °F)

Operating Humidity: 10 % ~ 75 %

Weight: 2.7 kg (6.0 lbs).

Dimensions: 430 (W) x 98 (H) x 242 (D) mm
16-15/16" (W) x 3-7/8" (H) x 9-9/16" (D) inch

Note: Designs and specifications are subject to change without notice.

Features for a Quality Picture

Digital Auto Picture
Automatically controls the video output signal for less noise depending on the tape condition.

Digital Auto Tracking
Continuously analyzes the signal and adjusts for optimum picture quality.

Manual Tracking Control (to reduce picture noise)
Use during Playback and Slow Motion mode to reduce picture noise.

Press CH (TRACKING) ▲/▼ on the remote control or on the VCR until the picture clears up.
To return to Auto Tracking, press POWER off, then on again a few seconds later.

V-Lock Control (to reduce picture jitter)
In Still mode, CH (TRACKING) ▲/▼ operate as a V-Lock control.

Auto Clock Set
If Auto Clock Set was incomplete.

Press ACTION on remote to display CLOCK screen.

Press ▲/▼ to select the month and ► to set. In the same manner, select and set the date, year, time, and DST (Daylight Saving Time).

Press ACTION to start clock, and go to step 4 above.

Press ▲/▼ to select the month and ► to set. In the same manner, select and set the date, year, time, and DST (Daylight Saving Time).

Press ACTION to start clock, and go to step 4 above.

Press ▲/▼ to select the month and ► to set. In the same manner, select and set the date, year, time, and DST (Daylight Saving Time).

Press ACTION to start clock, and go to step 4 above.

Press ▲/▼ to select the month and ► to set. In the same manner, select and set the date, year, time, and DST (Daylight Saving Time).

Press ACTION to start clock, and go to step 4 above.

Press ▲/▼ to select the month and ► to set. In the same manner, select and set the date, year, time, and DST (Daylight Saving Time).

Press ACTION to start clock, and go to step 4 above.

Press ▲/▼ to select the month and ► to set. In the same manner, select and set the date, year, time, and DST (Daylight Saving Time).

Press ACTION to start clock, and go to step 4 above.

Playback / Record on a Tape

Playback a Tape

1 Insert a tape.

• Loose or peeling labels may cause tape jam.

2 Press PLAY to play tape.

• If tape has no rec. tab (p. 3), auto play begins.

Record on a Tape

1 Insert a tape with a record tab (p. 3).

2 Press CH ▲/▼ or NUMBER keys to select the channel.

• For "LINE" input, see p. 9 of "Advanced Operations" book.

• If recording from a channel over 100, first press 100 key then the other 2 digits.

3 Press SPEED to select record speed (p. 3).

4 Press REC to start recording.

• To edit, press PAUSE/SLOW to pause, and again to resume recording.

5 Press STOP to stop recording.

One Touch Recording
(record in progress)
Press REC repeatedly to set length as follows:
30 min. → 1 hr. → 1:30 → 2:00 → 3:00
→ 4:00 → exit.
The VCR shuts off at the length set.

Record one station, watch another
Press VCR/TV ("VCR" goes out on Multi Function Display), → select channels on TV (recording continues).

Select channels on VCR (in STOP or PAUSE mode)
Press VCR/TV ("VCR" lights up on Multi Function Display), → select channels on VCR.

Notes

• Watching one channel and recording another is not possible when using Cable Box or DSS Receiver.

• After 5 minutes in Pause mode, VCR stops to protect the tape and the video heads.

3 Press STOP to stop tape.

Press REW or FF in Stop mode to Rewind or Fast Forward tape.

Press EJECT on remote, or STOP/EJECT on VCR to eject tape.

Auto Operation Functions

Auto Play
Insert a tape → Power comes on → Play starts if there is no record tab (see p. 3).

Auto Rewind
Play
Fast Forward } → Tape end → Rewind

Play Auto Eject
(Repeat Play must be off)
Play → Tape end → Rewind → Tape ejects if there is no record tab

Important: If a remote control button does not work when pressed, press the VCR button on the remote and try the button again.

Timer Recording

Timer Recording

1) Press PROG/VCR+* button.

2) Press ▼ to display program screen.

Example Today

8-9-31-1-2-3-6
7-8-9-31-1-2-3-6
WEEKLY (SAT) WEEKLY (MON) WEEKLY (SUN)

1) Press DATE, press ▲ to select: 1-31= one time, or DAILY= MON- FRI, or WEEKLY= same time each week and press ►.

2) Set remaining items, press ▲ to set START/ STOP times, CH(channel) or LINE input (p. 9 of "Advanced Operations" book), and tape speed (p. 3).

Press PROG/VCR+ button to end programming.

To Enter More Programs
Press ▲ to select and press ► to set an unused program. Then, repeat step 2.

Or, press PROG/VCR+ button to exit.

Review, Replace, or Clear Program

(Recording is not in progress)

a) Press PROG/VCR+ button.

2) Press ◀▶ to select LIST.

Cancel a Timer Recording
(Recording is in progress)

Press POWER and then STOP within 10 seconds to cancel the Timer Recording. (The TIMER indicator goes out on Multi Function Display.)

Light Tower Universal Remote Control

LIGHT button: When pressed, available buttons light and selected mode button (TV, VCR, or DSS/CABLE) flashes 5 seconds. If no button is pressed, light goes out in 5 seconds. Also, hold down a button to confirm the selected mode (mode button flashes) in the dark.

EJECT button: Press to eject tape. EJECT is not available during recording.

Location of Controls

Remote Control Buttons

EJECT (Ejects tape)

POWER (Turns VCR off/on)

VCR (mode) (Enables VCR functions)

VCR/TV (For TV or VCR mode)

PLAY (Plays a tape/FAST FORWARD/SEARCH (Fast forwards tape/ forward visual search)</

Before Requesting Service

Check the following points once again if you are having trouble with your VCR.
(BO : refers to "Basic Operations" Instruction book.)
(AO : refers to "Advanced Operations" Instruction book.)

Power	Correction
No power...	<ul style="list-style-type: none"> Completely insert Power Plug into an AC outlet. Set POWER button to on. Make sure power source is active.
Recording & Playback	Correction
TV program cannot be recorded...	<ul style="list-style-type: none"> Check connections between VCR, external antenna, and TV. Check connections selection. (BO p. 4, AO p. 3) Make sure your antenna system (CABLE or TV) is correctly set. (Channels [AO p. 12]) Make sure cassette record tab is intact. (BO p. 3)
Timer recording cannot be performed...	<ul style="list-style-type: none"> Confirm that clock is set to current time and date. Make sure Cable/DSS box (if used) is left on and tuned to channel to be recorded. Set recording start/stop times correctly. (BO p. 6) Make sure VCR POWER button is pressed off. (BO p. 6) Timer recording may not be performed or continued if a power interruption occurs before or during a Timer Recording, even after power is restored.
There is no playback picture, or the playback picture is noisy or contains streaks...	<ul style="list-style-type: none"> Select channel 3 or 4 on TV to match VCR output channel (3 or 4) (BO p. 4) or select LINE. Set VCR/TV selector to "VCR." Adjust TRACKING control in either direction. (BO p. 3) Try Head Cleaning. (BO p. 3)
Special effects playback, picture may contain some vertical jitter when using a TV with an Automatic Vertical Hold Control...	<ul style="list-style-type: none"> Set TV's Vertical Hold Control to MANUAL, then adjust.
VCR cannot be controlled...	<ul style="list-style-type: none"> Make sure VCR power is on. Check Remote batteries. Make sure VCR LOCK is set to off. (AO p. 10) Make sure Timer Record is not in progress.
Remote Control	Correction
VCR cannot be remote controlled...	<ul style="list-style-type: none"> Make sure VCR power is on. Make sure Remote is in VCR mode. Aim Remote Control directly at remote sensor on VCR. (BO p. 7) Avoid any object blocking signal path. Check Remote batteries. (BO p. 3) Make sure VCR LOCK is set to off. (AO p. 10) Exposing VCR remote sensor to direct fluorescent or outdoor light may cause signal interference.
ACTION and PROG/VCR+ buttons do not respond...	<ul style="list-style-type: none"> Check connections between VCR, external antenna, and TV. Press VCR button for VCR mode. (AO p. 2) Check Remote batteries. (BO p. 3)
Miscellaneous	Correction
Programs cannot be viewed on TV...	<ul style="list-style-type: none"> Make sure TV power is on. Make sure TV is set to output of VCR. Check connections between VCR, external antenna, and TV. Set VCR/TV selector to "TV." (BO p. 5) Make sure proper signal source is selected.
Video cassette cannot be inserted...	<ul style="list-style-type: none"> Insert the cassette with window side up; record tab facing you. Check if a tape is already in the unit.
Video cassette cannot be removed...	<ul style="list-style-type: none"> Completely insert Power Plug into an AC outlet.
Video cassette ejects when a recording is started or the power is turned off for timer recording...	<ul style="list-style-type: none"> Make sure cassette record tab is intact. (BO p. 3)
In Stop mode, the motor (CYLINDER) continues to rotate...	<ul style="list-style-type: none"> To enable Quick play mechanism, the cylinder will rotate for about 3 minutes. This reduces response time from Stop to Play mode and from Play to Rewind Search mode.

If you cannot resolve the problem, please call the Customer Call Center for product assistance at 1-800-211-PANA (7262).
To locate an authorized servicer, please call toll free 1-800-211-PANA (7262).
or send e-mail to : consumerproducts@panasonic.com

Panasonic Consumer Electronics Company,
Division of Matsushita Electric Corporation of America
One Panasonic Way Secaucus, New Jersey 07094

Panasonic Sales Company ("PSC"),
Division of Matsushita Electric of Puerto Rico, Inc.
Ave. 65 de Iniferter. Km. 9.5 San Gabriel Industrial Park,
Carolina, Puerto Rico 00985

Printed in Indonesia
LSQT0579B
S1201-1052

Copying Your Tapes (Dubbing)

Connection

(Rear connection shown.)

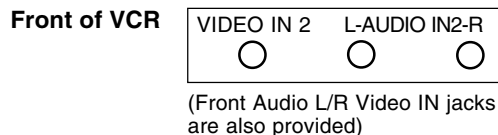
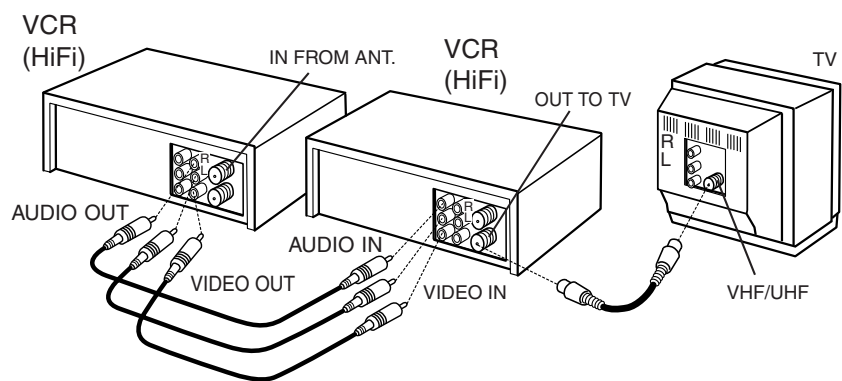

- Connect VIDEO OUT jack on Playing VCR to VIDEO IN jack on Recording VCR. To monitor the dubbing, also connect a TV as shown.
- Connect AUDIO L/R OUT jacks on Playing VCR to AUDIO L/R IN jacks on Recording VCR.

In place of a Playing VCR, you can use other equipment, such as a Camcorder. Simply connect the unit's Audio/video outputs to the Recording VCR.

Playing (Source) VCR

- Insert pre-recorded tape.

Insert blank tape with record tab.

2

Press INPUT* to set VCR Input mode to LINE1 for Video Input (Rear) or to LINE2 for Video Input (Front). (See "Selecting the Input Mode" below.)

3

Press PLAY, then PAUSE/SLOW immediately to enter PLAY/PAUSE mode. Press REC, then PAUSE/SLOW immediately to enter REC/PAUSE mode.

The operation of steps 4 and 5 must be done on both playing and recording VCRs at the same time.

4

Press PLAY to start dubbing. Press PAUSE/SLOW to start dubbing. Playing VCR starts playback. Recording VCR starts recording.

5

Press STOP to stop dubbing. Press STOP to stop dubbing.

To Monitor Dubbing on Your TV

- Turn your TV on and tune to the Recording VCR channel (CH3 or CH4).
- Set the VCR/TV Selector on the Recording VCR to "VCR."

Selecting the Input Mode

- Method 1:**
Press INPUT repeatedly. Channel Number ↔ LINE1 ↔ LINE2
- Method 2:**
Press CH ▲ / ▼.
Display will change as below.

Note • Dubbing tapes protected with Copy Guard will have poor quality results.

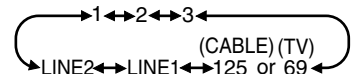

- "L1" or "L2" lights on Multi-Function Display (about 4 sec.) when LINE1 or LINE2 is selected.
- LINE1: For rear audio/video connection.
- LINE2: For front audio/video connection.

Caution: Unauthorized exchanging and/or copying of copyrighted recordings may be copyright infringement.

Special VCR Features

Tape Position Display Feature

To find out the present tape position. Tape position is displayed for VHS-C Cassettes type, tapes under 30 minutes, and some other tapes, but the position is not correct.

- Press TAPE POSITION to detect tape position.

DETECTING TAPE POSITION

REC STN END

"DETECTING TAPE POSITION" only appears the first time a cassette is inserted and it takes several seconds for correct indication to appear.

- The present tape position indication is displayed.

- Press TAPE POSITION to return to normal screen.

Remote Warning ON/OFF Feature

If Multi-brand feature is used (page 2), and this feature is set to on, a warning appears whenever an invalid key is pressed in TV, DSS, or Cable mode.

- Press ACTION to display menu.

Press ▲▼ to select REMOTE WARNING and press ► to set ON or OFF.
• If "OFF" remote warning will not appear if invalid key is pressed.

- Press ACTION to return to normal screen.

Auto Shut-Off Feature

The power shuts off at a preset time.

- Press ACTION to display menu.

Press ▲▼ to select AUTO SHUT-OFF. Press ► repeatedly to change shut-off time as shown below.

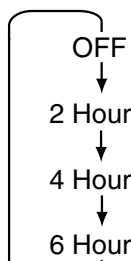

- Press ACTION to return to normal screen.

Note • The shut-off countdown will not function during Play or Record.

***Important:** If a remote control button does not work when pressed, press the VCR button on the remote and try the button again.

Weak Signal Display ON/OFF Feature

When set to "ON," picture is displayed regardless of signal strength.

- Press ACTION to display menu.

Press ◀▶ to select and display CHANNEL. Press ▲▼ to select WEAK SIGNAL DISPLAY, and press ► to set ON or OFF.

- ON: Picture is displayed despite signal condition an may have poor quality.
- OFF: Screen turns solid blue when signal is weak or non-existent.
- Selecting ON has no effect on connected equipment with blue back feature.

VCR Lock Feature

When set to ON, all operations except for timer record and tape eject are prohibited. Useful for households with small children.

VCR LOCK ACTIVATED

VCR LOCK OFF

To turn on, hold down REC on the VCR in Stop mode with no tape inserted for 7 sec. (Please ignore the NO CASSETTE warning.)

To turn off, repeat above.

- VCR Lock cancels in 24 hours if clock is set.

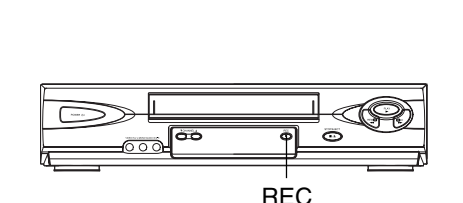

REC

OFF
2 Hours
4 Hours
6 Hours

***Important:** If a remote control button does not work when pressed, press the VCR button on the remote and try the button again.

On-Screen Displays (OSD)

On-Screen Displays (OSD)

Function & Channel Displays
When a function button is pressed, e.g. PLAY, or you change channels, a 5 second display appears.

VCR Status & Clock Displays
To display or remove overlay at right, → press DISPLAY*.

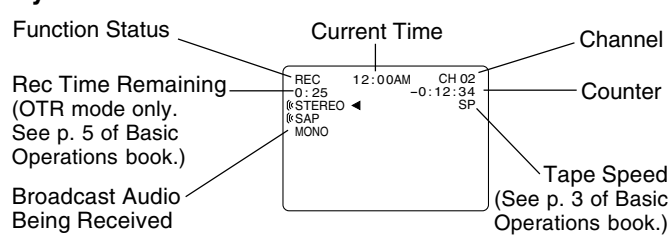

Warning and Instruction Displays

These displays will alert you to a missed operation or provide further instructions.

OSD	Caution	Page
PLEASE SET CLOCK BY PRESSING ACTION KEY	If you attempt to set or review a Timer Recording and the Clock is not set...	See page 6 of Basic Operations book
TURN VCR OFF FOR TIMER RECORDING	After a Timer Program has been set...	See page 6 of Basic Operations book
CHECK CASSETTE RECORD TAB	If you press REC on the remote control or VCR, and a cassette is inserted with no record tab...	See page 3 of Basic Operations book
NO CASSETTE	If you press PLAY, FF, REW, or REC on the remote control or VCR without a cassette inserted...	See page 5 of Basic Operations book
TO CANCEL TIMER REC PRESS POWER THEN STOP KEY	If you press POWER or STOP during a Timer Recording... (visible in VCR mode only)	See page 6 of Basic Operations book
VIDEO HEADS MAY NEED CLEANING PLEASE INSERT HEAD CLEANING CASSETTE OR REFER TO MANUAL	If head cleaning becomes necessary while playing back a tape...	See page 3 of Basic Operations book
END :PLAY		
VCR LOCK ACTIVATED	If you press a function button other than STOP/EJECT or POWER while the VCR is in VCR Lock mode...	See page 10
REMOTE CONTROL IS SET TO CABLE/DSS MODE	If you press an invalid key on the remote while in CABLE/DSS mode...	See pages 2, 10
USE VCR : VCR KEY		
REMOTE CONTROL IS SET TO TV MODE	If you press an invalid key on the remote while in TV mode...	See pages 2, 10
USE VCR : VCR KEY		

***Important:** If a remote control button does not work when pressed, press the VCR button on the remote and try the button again.

Reset Language, Channels, Clock, VCR's Output Channel

Press ACTION to display MENU.

Language

- Press ▲▼ to select language item.

For English

- Press ► repeatedly.

For Spanish

For French

- Press ACTION to exit.

For English

For Spanish

For French

- Press ACTION to exit.

For English

For Spanish

For French

- Press ACTION to exit.

For English

For Spanish

For French

- Press ACTION to exit.

For English

For Spanish

For French

- Press ACTION to exit.

For English

For Spanish

Channels

- Press ▲▼ to select CHANNEL.

For English

For Spanish

For French

- Press ACTION to exit.

For English

For Spanish

For French

- Press ACTION to exit.

For English

For Spanish

For French

- Press ACTION to exit.

For English

For Spanish

For French

- Press ACTION to exit.

For English

For Spanish

For French

- Press ACTION to exit.

For English

For Spanish

For French

Clock

- Press ▲▼ to select CLOCK.

For English

For Spanish

For French

- Press ACTION to exit.

For English

For Spanish

For French

- Press ACTION to exit.

For English

For Spanish

For French

- Press ACTION to exit.

For English

For Spanish

For French

- Press ACTION to exit.

For English

For Spanish

For French

- Press ACTION to exit.

For English

For Spanish

For French

Time Zone Adjust

- Press ▲▼ to select "TIME ZONE ADJUST"

For English

For Spanish

For French

- Press ACTION to exit.

For English

For Spanish

For French

- Press ACTION to exit.

For English

For Spanish

For French

- Press ACTION to exit.

For English

For Spanish

For French

- Press ACTION to exit.

For English

For Spanish

For French

- Press ACTION to exit.

For English

For Spanish

For French

VCR's Output Channel

- Press ▲▼ to select "VCR'S OUTPUT CH."

For English

For Spanish

For French

- Press ACTION to exit.

For English

For Spanish

For French

- Press ACTION to exit.

For English

For Spanish

For French

- Press ACTION to exit.

For English

For Spanish

For French

- Press ACTION to exit.

For English

For Spanish

For French

- Press ACTION to exit.

For English

For Spanish

For French

Add or Delete a Channel

To add channel: Select channel with NUMBER keys and press ADD/DLT.

CHANNEL 08 ADDED

To delete channel: Select channel with CH ▲▼ or NUMBER keys and press ADD/DLT.

CHANNEL 08 DELETED

For English

Multi-Brand Control Feature

Multi-Brand Control Setup

The Remote Control can be set to control some TV and Cable box/DSS functions.

1 Find your TV and Cable Box/DSS Receiver Brand Code Number from those shown below.

- Setup for TV control,**
 - hold down **TV** button,
 - enter code with **NUMBER** keys.
- Setup for Cable or DSS control,**
 - hold down **DSS/CABLE** button,
 - enter code with **number** keys.
- If code number is 100 or greater,
 - press 100 key, then other digits. E.g., press 100 - 0 - 2 for 102.

3 Confirm code entry,

- press **POWER** to turn your TV on or off.
- See table below for controllable functions in each mode.

- Repeat setup after remote battery replacement.
- Remote will not control every TV, cable box, or DSS made by the manufacturer listed. If you get no response, your particular unit cannot be controlled. There are NO additional codes for the products listed. If your product is not listed, then the remote is not compatible with that product.

Using Multi-Brand Control

After remote is set up, you can select VCR, TV, or DSS/CABLE for the desired function.

Press **VCR**, or **TV**, or **DSS/CABLE** on the remote.

(Table below shows available unit buttons for each mode.)

Unit Mode	VCR	TV	CABLE/ DSS
VCR	All	VOL UP/DOWN	
TV	VCR/TV, PLAY, STOP, EJECT, SAP/Hi-Fi, DISPLAY, FF, REW, PAUSE/SLOW, REC, SPEED, CA/ZERO, COUNTER RESET, TAPE POSITION	POWER, INPUT, number keys, ENTER, CH UP/DOWN, VOL UP/DOWN	
CABLE/ DSS		VOL UP/DOWN	POWER, ENTER, NUMBER KEYS (except 100key), CH UP/ DOWN

- Not all functions listed may be controllable.
- In TV or DSS/CABLE mode, it may be necessary to press ENTER after pressing NUMBER keys for channel selection.

TV Brand Code Numbers			
Panasonic	01, 02	Sylvania	05
Quasar	01, 02	Sharp	06, 07
RCA	03	Sony	08
GE	03	Toshiba	09
Zenith	04	Sanyo	10
Magnavox	05	Fisher	10
JVC	11	Hitachi	12
Mitsubishi	07, 13	Samsung	14
Gold Star	15, 16, 17		

Cable Box Brand Code Numbers			
Archer	05, 06, 01, 44, 63, 91, 126	Quest	05, 06
Cabletenna	01, 44, 63, 91, 126	Radio Shack	51, 44, 59, 75, 126
Cableview	63, 44, 42, 30, 52, 04, 124, 126	RCA	16, 17, 97, 109
Century	51, 44, 59, 75, 126	Realistic	51, 44, 59, 75, 126
Citizen	63, 44, 42, 30, 52, 04, 124, 126	Recoton	51, 44, 59, 75, 126
Curtis	08, 09, 61, 53, 87	Regal	14, 15, 28, 41, 102, 103, 104, 108, 130
Diamond	01, 44, 63, 91, 126	Regency	104, 108, 130
Drake	67	Rembrandt	01, 32, 39, 42, 44, 63, 126
Eagle	13, 22, 58, 62, 20, 40, 26, 107	Salora	68
Eastern	28, 130	Samsung	05, 32, 40, 42, 06
GC Brand	63, 44, 42, 30, 52, 04, 124, 126	Scientific Atlanta	08, 09, 61, 53, 87
Gemini	04, 124	Sheritech	27
General Electric	57, 01	Signal	26, 112
General Instruments	01, 02, 03, 04, 34, 55, 83, 106	SL Marx	32, 40, 42, 06, 43, 44, 52, 63, 126
Jasco	04, 124	Sprucer	16, 17, 97, 109
Jerrold	01, 02, 03, 04, 34, 55, 83, 106	Standard Components	32, 39, 42, 44, 126
Macom	31	Stargate	32, 40, 63, 44, 42, 30, 52, 04, 06, 124, 126
Matsushita	26, 112	Tecomm	33, 34, 01, 42, 66, 91
Movietime	32, 39, 42, 44, 126, 38, 40	Teknika	74
NEC	38, 40, 32	Telectapton	77, 127
NOVAVISION	08, 09, 61, 53, 87	Television	32, 40, 42, 06
Philips	13, 20, 23, 24, 50, 128, 129	Unika	01, 44, 63, 91, 126
Pioneer	05, 06	Universal	42, 43, 44, 52, 63, 126
Pulsar	63, 44, 42, 30, 52, 04, 124, 126	Viewway	07, 23, 50, 129
		Vid Tech	64
		Videk	16, 17, 97, 109
		Viewstar	13, 22, 58, 62, 20, 40, 26, 107
		Zenith	07, 23, 50, 129

DSS Brand Code Numbers			
Toshiba	92	Panasonic	96
Hitachi/Hughes	93	RCA	97
Magnavox/Uniden 1	94	Sony	98, 105
Magnavox/Uniden 2	95		

- Due to changes in infra-red commands used by manufacturers, some brands have several codes. If your unit does not respond to the first code, please try the next one.
- Some TV, Cable Box and DSS Box brands require you to turn on the power manually.

Advanced Connections

Audio/Video connection

If your TV has AUDIO IN and VIDEO IN terminals, you can connect your VCR to them to receive higher quality picture and sound.

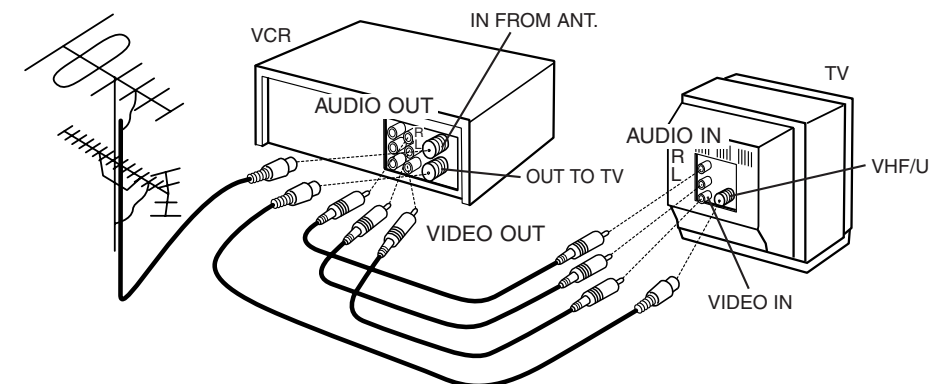

1 Connect the VCR's VIDEO OUT jack to the TV's VIDEO IN jack.

2 Connect VCR's L/R AUDIO OUT jacks to the TV's L/R AUDIO IN jacks.

3 Set the VIDEO/TV selector of your TV (Monitor/Receiver) to "VIDEO."

With a Cable Box (VCR → Cable Box)

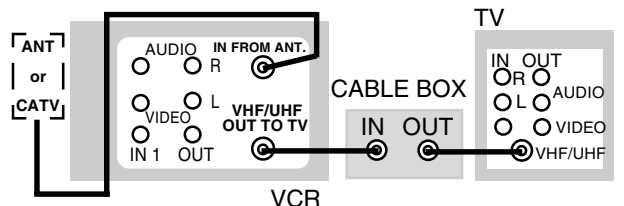

Connect with Two Cable Boxes

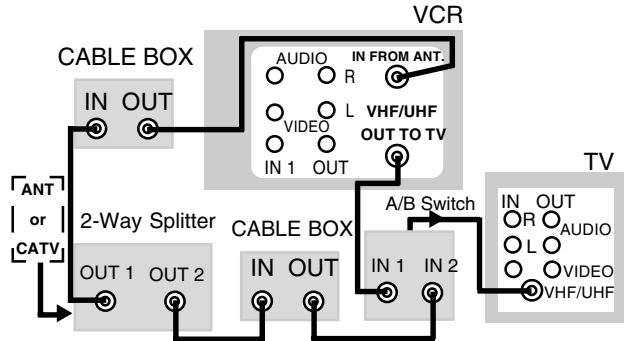

You Can

- view any (including scrambled) channel.
- use VCR Remote Control to select channels without using Multi-brand control feature.

You Cannot

- record scrambled channels.
- view channel other than the one selected for any type of recording.
- do a Timer recording of a channel unless you select it at the cable box.

MTS Broadcast/VHS Hi-Fi Stereo System

Connection

Make the Audio/Video Connection as shown on page 3. You can use a TV connected to Stereo amp and speakers instead of a Stereo TV.

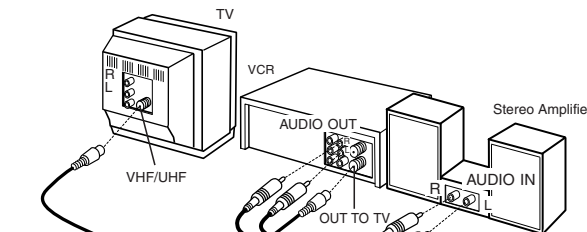

Equipped with dbx®-TV Noise Reduction for true MTS reproduction. dbx®-TV Noise Reduction is required for good stereo separation and audio fidelity. dbx® is a registered trademark, and is licensed by dbx® Technology Licensing.

Receivable Broadcast Types

The following are possible audio broadcast types and on-screen displays. The signal being received is indicated with an "R" mark while the selected audio mode is indicated with an arrow. To display the broadcast signal being received, press **DISPLAY**.

MTS Stereo and SAP broadcast

Multi-channel Television Sound Stereo (main language) and Secondary Audio Program (sub language) broadcasts are being received simultaneously. Select STEREO or SAP audio mode.

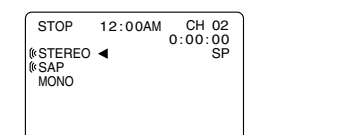

MTS Stereo broadcast

Multi-channel Television Sound Stereo broadcast. Select STEREO audio mode. If stereo broadcast is weak and display flickers, select MONO audio mode for possibly better results.

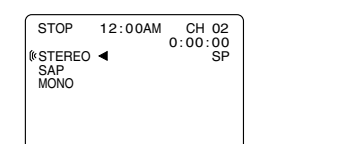

SAP broadcast

Secondary Audio Program (sub language) broadcast. Select SAP audio mode for the sub language.

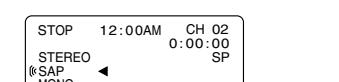

MONO broadcast

Normal monaural sound broadcast.

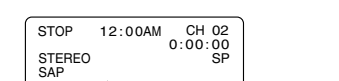

Audio Mode for Recording

- Press **SAP/ Hi-Fi** to display audio mode. (Display disappears after 5 seconds.)
- Press **SAP/ Hi-Fi** repeatedly to select desired mode.
 - Refer to "Receivable Broadcast Types" above.
 - Arrow indicates selection.
- Do a recording. See p. 5 of "Basic Operations" Instruction book.

Notes

- Only tapes recorded in Hi-Fi stereo will playback with true stereo sound. Standard stereo tapes will playback in monaural sound.
- To listen to Hi-Fi stereo playback, the VCR AUDIO (L/R) jacks must be connected to a stereo TV or an external stereo amp and speakers. (See top of this page.)
- If tracking is adjusted during playback, Hi-Fi audio may revert to normal audio.
- Hi-Fi and normal audio playback volume level may differ.

Important: If a remote control button does not work when pressed, press the VCR button on the remote and try the button again.

Timer Recording Using VCR Plus+® System

VCR Plus+ System is... This feature sets most items of a Timer Recording when you enter a PlusCode programming number found in TV GUIDE and selected newspaper TV listings.

Initial Setup.... To use VCR Plus+ system, clock and channels must be set (p. 4 of "Basic Operations" book). **Channel Setup....** Broadcast/ cable stations are assigned a VCR Plus+ (GUIDE CH) number. See the Channel Listing (directory) page of TV GUIDE, etc. In the Channel Setup below, you will be entering your local channel number (RECEIVE CH) for each GUIDE CH number. **Example :** If NBC's assigned GUIDE CH were 05, and your TV received NBC on channel 04, you would enter 04 across from GUIDE CH 05 in step 3 of "VCR Plus+ System Channel Setup".

VCR Plus+ System Channel Setup

For [VCR-TV] or [VCR-cable box-TV] connection only. You'll need a local TV channel listing (e.g. TV GUIDE) which includes the assigned VCR Plus+ numbers.

- Press **PROG/VCR+** button to display PROGRAM. Press **PROG/VCR+** button to display VCR Plus+ screen.
- Press **PROG/VCR+** button to display PROGRAM. Press **PROG/VCR+** button to display VCR Plus+ screen.
- Press **PROG/VCR+** button to display PROGRAM. Press **PROG/VCR+** button to display VCR Plus+ screen.
- Press **PROG/VCR+** button to display PROGRAM. Press **PROG/VCR+** button to display VCR Plus+ screen.
- Press **PROG/VCR+** button to display PROGRAM. Press **PROG/VCR+** button to display VCR Plus+ screen.
- Press **PROG/VCR+** button to display PROGRAM. Press **PROG/VCR+** button to display VCR Plus+ screen.
- Press **PROG/VCR+** button to display PROGRAM. Press **PROG/VCR+** button to display VCR Plus+ screen.

Do normal Timer Record if... PlusCode number is not listed for program. program (e.g. sports event) may run over set stop time. See page 6 of "Basic Operations" book to: cancel a timer recording in progress. review, replace, or clear program contents. **Important for DSS/Cable Box Users** When recording via DSS, the receiver must be left on. When recording via cable or antenna, DSS receiver must be off. When recording via a cable box, leave box on and tuned to channel to be recorded.

Tape Operation

- Repeat Play** Set to playback a recording over and over.
- Zero Search** To quickly return to a specified tape location.
- 1 Press ACTION** to display menu.
- 2 Press RESET COUNTER** at desired position to reset to "0:00:00".
- 3 Continue to record, playback, etc.**
- 4 Press STOP.**
- 5 Press CA/ZERO** in Stop mode to start ZERO SEARCH.

Timer Operation

COMMERCIAL → ADVANCE® marks start and end points of commercials within recordings over 15 minutes long. The VCR automatically advances through marked commercials at high speed. Or, you may set to manual. Because stations broadcast differently, the effectiveness of this feature may vary. See bottom of page for answers to commonly asked questions about this feature.

COMMERCIAL → ADVANCE® Marking

With C/A RECORD: ON, the VCR auto rewinds after a recording is made and marks start and end points of all detected commercial blocks. After marking, the tape is returned to end of recording. Commercials are not erased.

- Press **PROG/VCR+** button to display PROGRAM. Press **PROG/VCR+** button to display VCR Plus+ screen.
- Press **PROG/VCR+** button to display PROGRAM. Press **PROG/VCR+** button to display VCR Plus+ screen.
- Press **PROG/VCR+** button to display PROGRAM. Press **PROG/VCR+** button to display VCR Plus+ screen.
- Press **PROG/VCR+** button to display PROGRAM. Press **PROG/VCR+** button to display VCR Plus+ screen.

ON: Timer recording, VCR Plus+ System, and One Touch recordings are marked automatically. When timer is used to record two consecutive shows (same channel), greater accuracy can be obtained by programming each show separately. When STOP is pressed during normal recording, press: a) 1 key (NOW) → to mark now. "NOW MARKING COMMERCIALS" appears. b) 2 key (LATER) → to mark after power is turned off. (If tape is rewound and another recording is started before power is turned off, correct marking may not occur. c) ACTION (CANCEL) → marking is canceled. **OFF:** The VCR will not mark commercials. Select when editing or dubbing a tape, or when opting not to use this feature.

The most commonly asked questions about COMMERCIAL → ADVANCE® are answered below.

Question	Answer
How fast does the VCR advance through commercials?	The VCR advances through a 3-minute commercial block in about 8 to 12 seconds if the tape speed is SLP. In SP, it takes about 25 to 35 seconds.
Are commercials advanced through only when playback a recording?	Yes. The commercials are not marked until after the recording is finished.
Are commercials still recorded on the tape in case I choose to view them sometime?	Yes. By setting the C/A PLAYBACK to MANUAL, see top of this page, you can view or advance through commercials as desired.
Does the VCR advance through commercials each time I playback tapes which were recorded using COMMERCIAL → ADVANCE?	Yes. As long as C/A PLAYBACK is set to AUTO, see top of this page, the VCR will advance through commercials each time the tape is played back.
After marking commercials, does the VCR stop at the end of the tape, or rewinding to the beginning?	The tape stops at the end of the recording so that any additional timer recordings can be performed.
Can I play my COMMERCIAL → ADVANCE recordings in non-COMMERCIAL → ADVANCE VCRs?	Yes. COMMERCIAL → ADVANCE marked recordings will play in non-COMMERCIAL → ADVANCE VCRs, but commercials will not be advanced through.
Does the marking process interfere with other programmed recordings?	No. If the interval between 2 or more timer programs is not sufficient to mark the recording, marking will be done after all recordings are complete and the power goes off.
What happens if I cancel the marking in progress so I can use the VCR?	Marking will be resumed when the VCR's power is turned off as long as the tape has not been ejected.
What if part of my program is advanced through along with the commercials?	Please see the 3rd note on top of this page.
Additional Notes:	
• Because of the various ways in which commercials are broadcast, the VCR may not be able to recognize all commercials.	
• If a timer recording is scheduled for the middle of the night, please be aware that the VCR will make some noise as it rewinds and fast forwards the tape while marking commercials.	

COMMERCIAL → ADVANCE® and MOVIE → ADVANCE® are registered trademarks of SRT, Inc. A Jerry Iggulden invention licensed in association with Arthur D. Little Enterprises, Inc. U.S. Pat. No. 5,333,091; 5,692,093; 5,696,866 other patents pending

Tape Operation

MOVIE → ADVANCE® Playback

MOVIE → ADVANCE® helps you locate certain parts of prerecorded movies (rented or purchased). The feature works in two ways. You can go to the beginning of the movie. You can skip from one preview to the next. MOVIE → ADVANCE® works only on tapes recorded in SP speed with the record tab removed.

- Insert a tape without record tab.
- Press **SEARCH/ M/A SKIP** to display SEARCH.
- Press **SEARCH/ M/A SKIP** twice to select MOVIE and press **SEARCH/ M/A SKIP** to select GO TO START MOVIE or GO TO PREVIEW.

Select "GO TO START MOVIE," if you want to advance directly to beginning of the movie. → continue with step 4. Select "GO TO PREVIEW," if you want to view the first (next) preview. → go to "To Search for Preview" at right.

- Press **PLAY** to start playback.
- Press **SEARCH/ M/A SKIP** to start playback.
- Press **PLAY** to start playback.

When the movie is found... Press **PLAY** to start playback. Press **SEARCH/ M/A SKIP** to cancel, press STOP.

Search System

For each recording, an invisible index mark is placed on the tape. A program index and information are also included for timer recordings. These marks are used to access or scan recordings.

Index Search

- Press **SEARCH/ M/A SKIP** to display SEARCH. In Stop or Play mode, and then press NUMBER keys to select recording number. To calculate number, see below. Press FF or REW on the remote to start search. Play begins at search end. To search forward or back 1 index, press FF or REW on the remote or VCR while screen left is displayed (10 sec.). To cancel, press STOP or PLAY.
- Press **SEARCH/ M/A SKIP** to display SEARCH. In Stop or Play mode, and then press NUMBER keys to select recording number. To calculate number, see below. Press FF or REW on the remote to start search. Play begins at search end. To search forward or back 1 index, press FF or REW on the remote or VCR while screen left is displayed (10 sec.). To cancel, press STOP or PLAY.

To Calculate Index Number

- Example 1:** To go to rec. 2 from rec. 4, enter 3 and press REW.
- Example 2:** To go to rec. 6 from rec. 2, enter 4 and press FF.

Upon locating end point, → search continues 7 sec. past end point, → tape rewinds to 10 sec. before end point, → tape plays to end point and stops. **NOTE:** ↑ indicates start points of each recording. **Note** If Index Search is started very close to an index mark, that index mark may not be counted in the search. **Important:** If a remote control button does not work when pressed, press the VCR button on the remote and try the button again.